

## Reliability.

It's the defining trait of our company and our forklifts.



UniCarriers' roots extend back over 100 years, and over that time, strong, reliable performance has always been the hallmark of our organization, our people and our equipment.

Today, our unrivaled reliability continues to provide UniCarriers' customers with a competitive edge. And together, we move the merchandise that moves world commerce with greater efficiency, economy and reliability.

When it comes to providing forklifts that make a difference for our customers and theirs...

**We Never Quit.**



**UNICARRIERS**  
FORKLIFT  
UniCarriersAmericas.com

SB-TX 07-2015 Printed in U.S.A.

UniCarriers® is a registered trademark of UniCarriers Corporation. OptiView® is a registered trademark of UniCarriers Americas. UniCarriers Americas Corporation reserves the right to make product changes relating to colors, equipment, specifications or available options without notice. For more information, contact your UniCarriers representative.



**UNICARRIERS**  
FORKLIFT



**3-Wheel Sit Down Forklifts**

**36 & 48 Volt AC-Powered  
3,000 / 3,500 / 4,000 lbs. Capacities | Cushion Tire**



**TX Series**

# TX Series Applications

With 100% AC motors that are both powerful and emissions-free, TX Series forklifts are the green choice for:

- Food Products Companies
- Warehousing Operations
- Manufacturing



Look for these symbols for features available only on UniCarriers forklifts or that provide a proven performance advantage as compared to competitive trucks.



## NEVER QUIT.

It defines our forklifts and the company that builds them.

Over the course of a century, the company known as UniCarriers took shape. As we grew and evolved into a US manufacturer with a global reach in nearly 100 countries worldwide, much has changed, but one thing hasn't: our mission. UniCarriers is committed to providing you with the ultimate in reliability, performance, and value.

And that commitment can be seen in the TX Series. It delivers the extraordinary maneuverability of a compact, 3-wheel truck to negotiate tight turns and narrow aisles — plus reliable 100% AC motors that eliminate emissions without sacrificing torque or power. The TX Series also offers the legendary reliability and uptime that define our brand — and is backed by the best standard, limited warranty in the business. It all adds up to the ultimate combination of versatility, economy and productivity.



### Up Your UpTime

Discover reliability features that cut downtime and keep your business up and running



### Comfort Zone

Your drivers and your entire operation will benefit from our comfort & productivity features



### Power & Performance

100% AC motors and controllers are only the beginning of our performance advantages



### Sweet Savings

The TX is designed to deliver you a low cost of ownership year after year after year



### Play It Safe

Safety is everybody's business, and the TX is all business when it comes to safety



### Control Freak

With the TX, you're in complete control when it comes to managing costs and productivity



### Make It Yours

Already well appointed, the TX can be customized to meet your specific needs



To learn more, and a find a dealer near you, visit [UniCarriersAmericas.com](http://UniCarriersAmericas.com)



# Up Your UpTime

TX Series forklifts incorporate a full range of advanced technologies to keep your operation up, running and productive. As a result, our trucks use fewer parts, require less scheduled maintenance, extend battery life and our ultra-reliable AC drive and hydraulic motors provide greater efficiency — delivering more consistent power and performance throughout each shift.



## Stay Cool

**Built-in thermal sensors** help protect the motor and controller systems, **promoting more reliable performance**. A warning will flash on the LCD screen to advise the operator if overheating has occurred, followed by reduced travel and lift operations. Information is automatically locked into the truck's service history to assist the technician and speed servicing.



## Reliable AC Technology

The TX Series is powered by our harmonized, 100% AC motor and controller system. With **better cooling capacity and greater reliability** even in humid environments, AC power delivers more consistent and higher performance throughout the shift on a single battery charge.



Easily check brake fluid levels on the front dash.

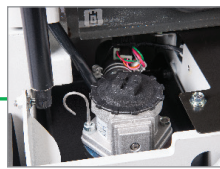

Quickly access dipstick and hydraulic fluid under the hood.

## Dependable Drive Unit

Dependable performance is achieved through the synching of our **brushless AC induction motors** with a simple, yet effective, transmission design. The result is less complexity, fewer parts and reduced maintenance.

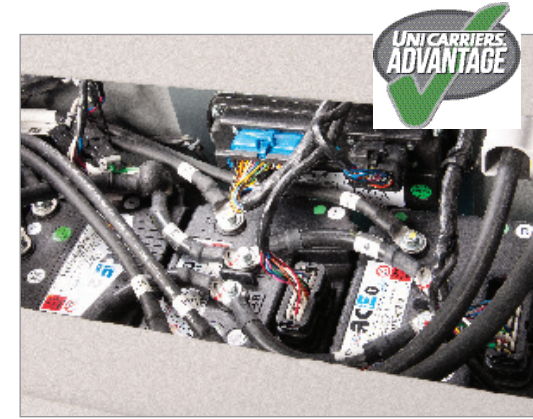

## Sealed Controller

The controllers are located in the rear of the truck — between the counterweight and the battery box— and protected by two removable panels. Their **IP65 rating** means they're housed within an enclosed and waterproof structure to protect against water and dust.

- 1 Switchback regeneration
- 2 Foot brake regeneration
- 3 Accelerator-off regeneration
- 4 Controlled rollback regeneration
- 5 Lifting/lowering regeneration

## Get More from Every Charge

Advanced regenerative technology **reclaims power** from five different operations, lowering power consumption and **reducing component wear** through less heat generation — to keep your equipment **operating longer**, with less time in the charging bay.

## Conserve Your Energy

With the standard **Auto Power Off** feature, power is cut off to the truck if it remains idle for a pre-set period of time. (Comes factory programmed at 15 minutes, but can be adjusted from 1–60 minutes.)



## On-Demand Power Steering

With load sensing power steering, a single motor powers both steering and hydraulics — **reducing the number of parts and energy consumption**.



# Comfort Zone



UniCarriers incorporates proven, ergonomic designs throughout the TX Series forklifts to optimize the comfort and visibility of your operators — while it maximizes the performance of your entire operation.



## Sit & Relax

A comfortable **full-suspension seat** absorbs shocks for a smoother, more comfortable ride — and features weight and back angle adjustments, hip restraints and a retractable seatbelt.



## We've Thought of Everything

Switching between the brake and accelerator is easier, more fluid and safer, thanks to our **heel-to-toe** concept that ensures the pedals are at the same height when released.



## A Step Up in Operator Comfort

Designed with a wide step for easy entry into the spacious cabin that boasts leg and foot room that are among the industry's largest. It also offers an amazing head clearance for such a compact forklift.



## Hands-On Operation

A standard small diameter, tilt steering wheel can be paired with an optional spinner knob for extra operator control. Further customize driver preference by selecting an optional steering column that provides an extra 2" of height.



## Battery Plug

Unlike competitive trucks, we've placed the battery plug under the hood and away from driver's legs.



## Visibly Better

The TX is designed to provide a commanding view of the surrounding environment and clear sightlines to the fork tips by virtue of the low-front dash panel.



## Perfectly Placed

Ergonomically placed parking brake, deck-mounted hydraulic controls and automotive-style forward/reverse directional controls, lights and turn signals put operator comfort and productivity all within easy reach.



## Performance at Your Fingertips

With our optional fingertip controls, you barely have to move your fingers to command control over travel direction, lift, auxiliary functions and horn. **Integrated into a comfortable armrest**, it provides operators with the ultimate in ergonomic efficiency. Choose between a combined or separate lift & tilt lever design.



# Power & Performance



The TX Series matches turn-on-a-dime maneuverability with power, torque, speed and control to deliver optimal performance and productivity for each application and in just about every environment.

## Smooth Moves

TX Series trucks are powered by two separate AC drive motors that are individually controlled by our AC Tech Controller. During tight turns, the inner wheel counter rotates so **the truck can turn within its own footprint** for unsurpassed maneuverability.

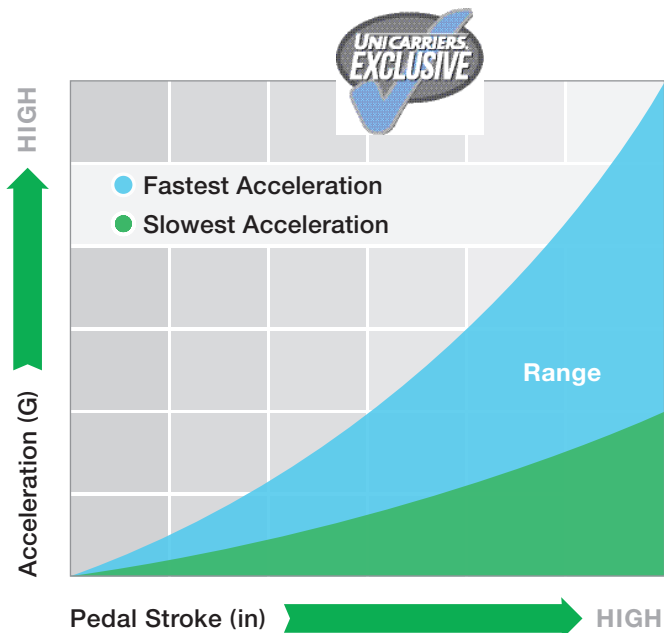
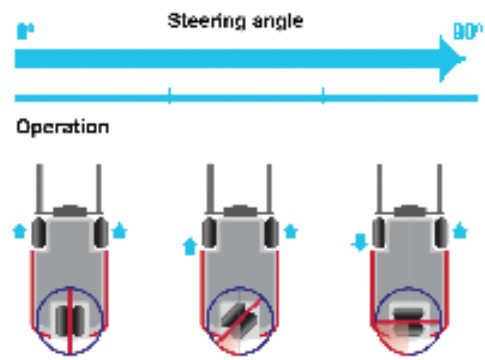

## Sensitive to Your Acceleration Needs

With our exclusive **Flex-Logic** system, the quicker the accelerator pedal is depressed, the faster our TX Series will respond to your command for speed. This feature is ideal for fast paced operations and where long runs are common. Operators can also maintain a slower acceleration rate by reducing their pedal force when pedestrians are present or in more confined areas of the warehouse. In addition, the operator can adjust the acceleration rate through the meter panel, for even faster or slower response.

## Peak Performance

Our top-end performance numbers are impressive, and so is the capability of TX Series forklifts to deliver **quicker acceleration and higher speeds** when you need to maximize work cycles and productivity.

<b>Travel Speeds</b> <b>9.0/9.9</b> <small>MPH</small> <small>36V / 48V</small>	<b>Lift Speeds</b> <b>61 / 72.8</b> <small>FPM</small> <small>36V / 48V</small>	<b>Gradeability</b> <b>18.7 / 17.9</b> <small>%</small> <small>36V / 48V</small>
--	--	---

Performance specifications above based on TX35 model.

## 3+1 Performance Modes = Greater Productivity

The TX Series features adjustable settings to optimize performance based on the application, work environment or operator experience. Choose from the three factory-set modes (shown below) to easily customize your lift truck. The TX also has a manual mode to create unique settings, finely tuned for your operator and operation.

- E Economy Mode**  
Extended operating hours achieved with only slightly reduced performance.
- P Power Mode**  
Offers mid-range settings for normal performance needs.
- H High Power Mode**  
To reach maximum desired performance.
- M Manual Mode**  
Provides access to customize performance parameters.



# Sweet Savings

At UniCarriers, we're always looking for opportunities to lower the cost of owning our trucks — and we've found them. Take a look at just a few of the ways we've designed the TX Series forklifts to be faster, easier and more economical to operate and maintain.



## Our Overhead Guard Reduces Your Overhead

The 4-piece overhead guard takes **75% less time to make needed replacements** versus competitors' single-piece, welded-on guards. That cuts downtime and costs.

## The Brake You Need

The reliable 6-disc wet-type brake system is fully enclosed within the drive unit. This design helps eliminate dirt and debris entry to **prevent premature brake wear**, keeps oil cleaner, extends brake life, lengthens service intervals and lowers your costs.



## More Power to You

Advanced regenerative technology reclaims power from five different operations — lowering power consumption, extending operating hours, reducing component wear and keeping your equipment out of the charging bay.



## Quick Check

A gas spring assist with locking mechanism provides easy access for the required daily battery and hydraulic fluid checks.



## On-Board Diagnostics

On-board diagnostics and truck service history are available through the meter panel for **quick troubleshooting** — resulting in less downtime and increased productivity. No tablet, laptop or handset tool is required.

## Fewer Motors to Maintain

The 100% AC-powered system on the TX features brushless drive and pump motors and a single contactor. The **steering system is electronically controlled and powered through the hydraulics**, thus eliminating the need for — and added expense of — a separate steering motor.

## Quick Fix

The modular design of the powertrain speeds and simplifies maintenance. The **gear box and motor can be removed, serviced and replaced as a unit** — without removing the mast for service.

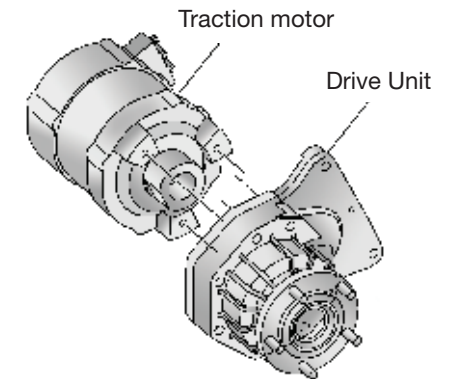

**1,200**  
**2,400**

## Low Maintenance

Extended major service intervals of 1,200 and 2,400 hours mean more uptime with less time, effort and money expended on maintenance.



# Play It Safe

You have a commitment to workplace and operator security. So do we. That's why you'll find some of the most sophisticated and reliable control systems on our TX Series forklifts — all designed to protect your employees and your business.



## Forward Thinking Back Up Alarm

Our back-up alarm provides plenty of notice to pedestrians and other drivers in the area. For applications with varying noise levels, there is an optional self-adjusting alarm that adjusts sound volume based on ambient noise levels.

Reverse driving actuates optional blue spotlight to illuminate the floor, for advanced visual warning.



## Parking Brake Alarm

As part of the Operator Presence System, a warning buzzer alerts the driver if he leaves the seat without first setting the parking brake.



## Password Protected Security

Using a PIN code/password entry feature helps assure that only authorized drivers are operating your TX. Up to five unique performance settings can be created, based on application and/or individual operator skill level.



## Operator Presence System

This comprehensive system includes a **seat-actuated power interrupt with mast-lock**, automatically preventing lift and tilt operations if the operator leaves the seat. The **return-to-neutral** feature minimizes forklift movement if the operator leaves the truck while still in gear. Other audible and visual warnings come standard, including a **seatbelt alarm and parking brake warning**.



## Seeing Is Believing

Cylinders are positioned behind the mast rails resulting in fewer visual obstructions for the operator. Ideal for facilities that transport delicate loads, our optional OptiView® mast makes fork positioning and load handling easier.

# Control Freak



Whether it's restricting access to the forklift, regulating travel speed or limiting operating costs, the TX Series provides you with the control you need to manage your operation easily, effectively and completely.

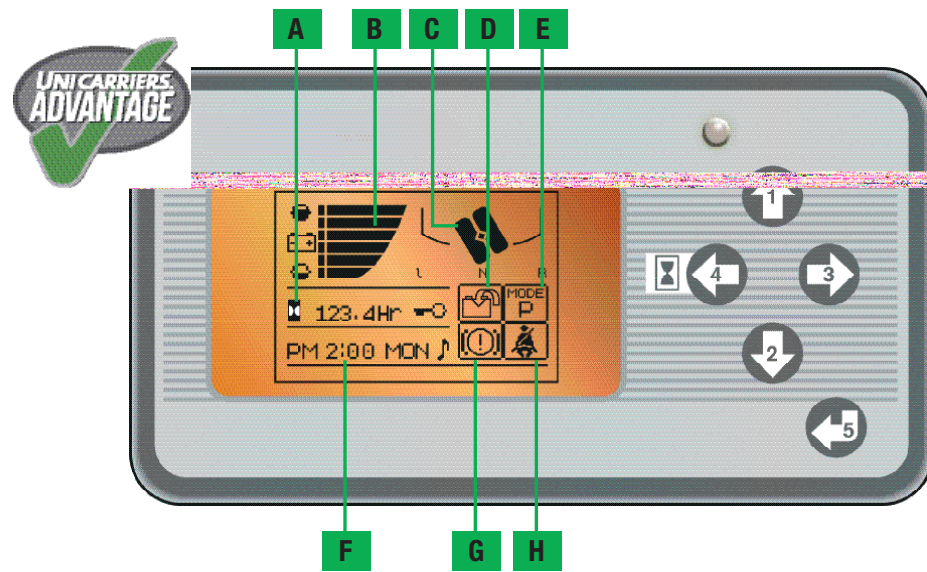

## The Ultimate In Control

The interactive meter panel on the TX provides operators and technicians with a wealth of information through its LCD warnings and readouts. Using the numbered function keys you can program settings, perform maintenance tasks, and access service history.

## Emergency Disconnect

The emergency disconnect button is strategically positioned for a quick, intuitive action.



Our multi-function display provides an at-a-glance view of critical functions:

- A** 4-Mode Hour Meter or Energy Consumption Indicator
- B** Battery Capacity Indicator
- C** Speed/Steer Wheel Indicator
- D** Regeneration Indicator
- E** Performance Mode
- F** Clock/Acceleration Level Adjustment
- G** Parking Brake Warning
- H** Seat Belt Warning

**UNI CARRIERS.**  
FORKLIFT

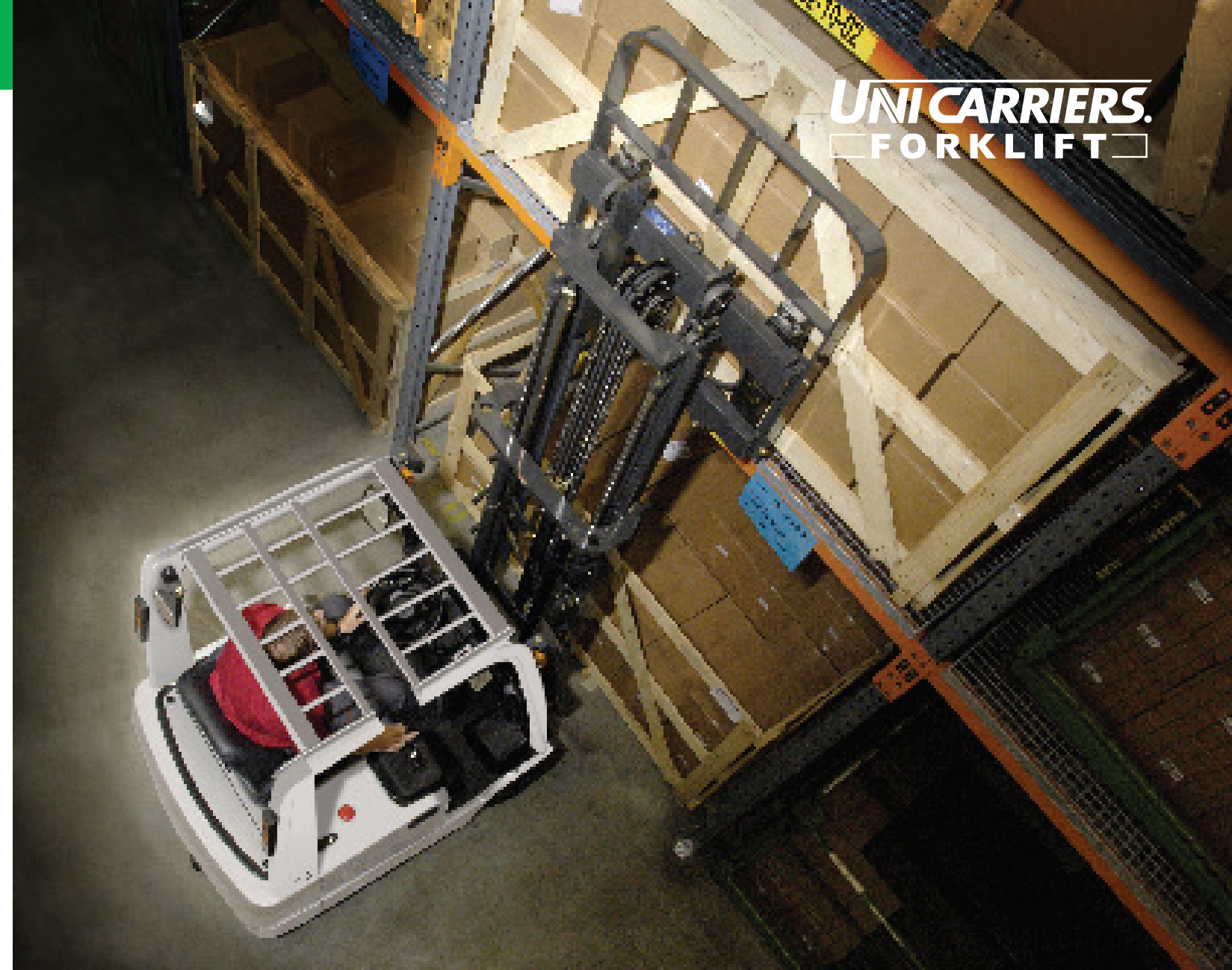

## Maintain Control

When operating on inclines, our **Controlled Rollback** feature uses regenerative braking to automatically maintain a slow, consistent speed on a ramp or incline when the accelerator pedal is released. This eliminates the need for continuous brake pedal force by the operator.



## Speed Synched

With our exclusive Flex Logic control, the **acceleration rate varies based on the speed at which the pedal is pressed** — fast acceleration for longer runs...or slower acceleration for easier maneuvering in higher traffic areas, tight spaces and making final approaches. See page 8 for details.





# Make It Yours

Unlike competitive brands, the TX Series comes standard with the most essential and popular features and accessories. In addition, we offer a complete menu of additional options that allow you to customize your forklift to fit your specific workplace environment, operations and business objectives. On these pages, you'll find available options that are both innovative and economical — but it's only a portion of what we offer. So if you don't see what you're looking for here, call your UniCarriers dealer for more options.



• Fire Extinguisher



• Steering Wheel With Spinner Knob

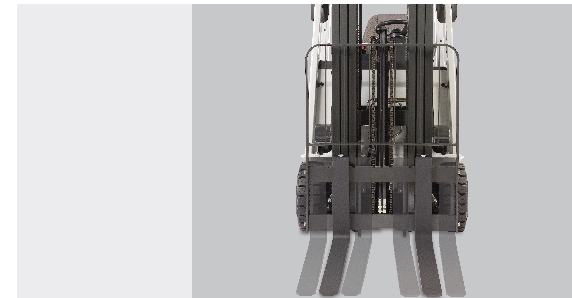

### Side-Shifting Fork Positioner

Hydraulic fork adjustment eliminates the need to manually move forks for different pallet types for increased productivity.



### Freezer Package

For operating in environments as low as -31°F (-35°C) — includes special hydraulic oil.



### Strobe Light

Available in a variety of colors.

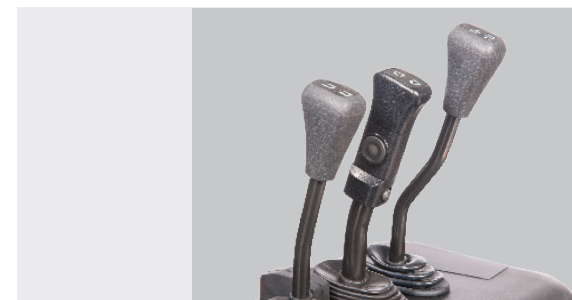

### Auto Fork Leveling

Conveniently located on the hydraulic lever, the thumb-activated button automatically stops forward tilt, bringing forks to 90° for easier load placement and retrieval.



### Battery Rollers

Simplify battery change-outs. Roller design includes a side panel that's easily removable for quick battery access.



### OptiView® Mast

Our exclusive 3-stage design provides wider sightlines and improved load handling visibility.



### Higher Steering Wheel

The stationary design provides an extra 2.2" of steering wheel height for enhanced operator comfort.



### Lower Overhead Guard

Designed with a 78.6" height for more confined, height-restricted areas. Other heights also available.



### Fingertip Controls

Fingertip controls integrated into an adjustable armrest for smoother, more precise control. Can be ordered with our exclusive single lift/tilt joystick.\*

\*Restrictions on combining this with other optional features may apply. Consult your authorized UniCarriers dealer for details.

## Option Availability

● Standard ○ Optional

VEHICLE MANAGEMENT	
AC TECH motor controller system	●
Interactive LCD meter panel with adjustable performance settings	●
Operator security PIN access	●
3 pre set performance modes (Economy, Power, High Power)	●
1 Manual (custom) performance mode	●
On-board diagnostics, self test and coded service history	●
Low battery lift interrupt system	●
Controlled rollback	●
BATTERY/ELECTRICAL	
36 Volt system	●
48 Volt system	○
Battery compartment rollers	○
BRAKE	
Hand applied parking brake with warning buzzer	●
5-mode regenerative braking	●
Fully enclosed 6-disc wet type brakes	●
MAST	
Seat actuated auto-mast lock system	●
OptiView® three-stage mast	○
HYDRAULIC SYSTEM	
Deck-mounted control levers	●
Electronic fingertip control levers (separate lift and tilt or single levers)	○
Auto-fork leveling	○
Accumulator	○
Extra tilt	○
OPERATOR CONVENIENCES	
Full suspension seat with weight adjustment	●
Overhead guard-mounted headlights and turn signals	●
Rearview mirrors	●
Rear combination light package (turn, stop, back-up)	●
Rear work light	●
Strobe lights	○
Steering wheel with spinner knob	○
Magnetic convenience box	○
Low overhead guard (78.6")	○
Solid pneumatic tires	○
PROTECTION/SECURITY	
Operator Presence System with return-to-neutral and auto mast lock	●
Back-up warning alarm	●
Self-adjusting back up alarm	○
Fire extinguisher	○

Some options may require additional lead time. Consult your authorized UniCarriers dealer for details. TX models conform to UL583 Type E.

## Specifications

SHORT MODEL CODE	LOAD CAPACITY lb (kg)	WHEELBASE in (mm)	OVERALL WIDTH in (mm)	MIN OUTSIDE TURNING RADIUS in (mm)	OVERHEAD GUARD HEIGHT in (mm)
TX30	3000 (1500)	51.2 (1300)	43.5 (1105)	60 (1525)	83.4 (2120)
TX35	3500 (1750)	51.2 (1300)	43.5 (1105)	60 (1525)	83.4 (2120)
TX40	4000 (2000)	55.5 (1410)	43.5 (1105)	64.4 (1635)	83.4 (2120)

## Pre-Set Performance Specifications

SETTING		TX30		TX35		TX40	
		36 V	48 V	36 V	48 V	36 V	48 V
<b>HIGH POWER</b>							
Travel Speed	Empty mph (kmh)	9.0 (14.5)	10.0 (16.0)	9.0 (14.5)	10.0 (16.0)	9.0 (14.5)	10.0 (16.0)
	Loaded mph (kmh)	9.0 (14.5)	10.0 (16.0)	9.0 (14.5)	10.0 (16.0)	9.0 (14.5)	10.0 (16.0)
Lift Speed	Empty fpm (mm/s)	101 (515)	118 (600)	101 (515)	118 (600)	101 (515)	118 (600)
	Loaded fpm (mm/s)	67 (340)	79 (400)	61 (310)	73 (370)	53 (270)	63 (320)
<b>POWER</b>							
Travel Speed	Empty mph (kmh)	8.8 (14.0)	9.7 (15.5)	8.8 (14.0)	9.7 (15.5)	8.8 (14.0)	9.7 (15.5)
	Loaded mph (kmh)	8.8 (14.0)	9.7 (15.5)	8.8 (14.0)	9.7 (15.5)	8.8 (14.0)	9.7 (15.5)
Lift Speed	Empty fpm (mm/s)	100 (510)	108 (550)	100 (510)	108 (550)	100 (510)	108 (550)
	Loaded fpm (mm/s)	62 (315)	71 (360)	57 (290)	63 (320)	51 (260)	58 (295)
<b>ECONOMY</b>							
Travel Speed	Empty mph (kmh)	8.1 (13.0)	8.8 (14.0)	8.1 (13.0)	8.8 (14.0)	8.1 (13.0)	8.8 (14.0)
	Loaded mph (kmh)	8.1 (13.0)	8.8 (14.0)	8.1 (13.0)	8.8 (14.0)	8.1 (13.0)	8.8 (14.0)
Lift Speed	Empty fpm (mm/s)	91 (460)	98 (500)	91 (460)	98 (500)	91 (460)	98 (500)
	Loaded fpm (mm/s)	54 (275)	59 (300)	51 (260)	51 (260)	46 (235)	47 (240)



Power, performance and reliability...all backed by the best standard limited warranty in the business!\*

• 2 Years • Unlimited Hours

\* Contact UniCarriers Americas for specific details, limitations, and exclusions.